

# PHILIPS

Yarrow



User manual  
Benutzerhandbuch  
Notice d'emploi  
Manual de usuario  
Manual do usuário  
Manuale d'uso  
Gebruiksaanwijzing

Incl.

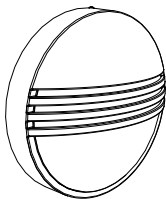

Excl.

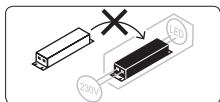
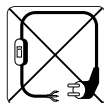
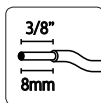
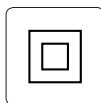
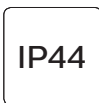
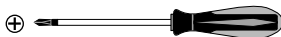
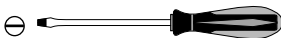
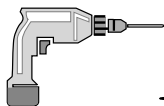

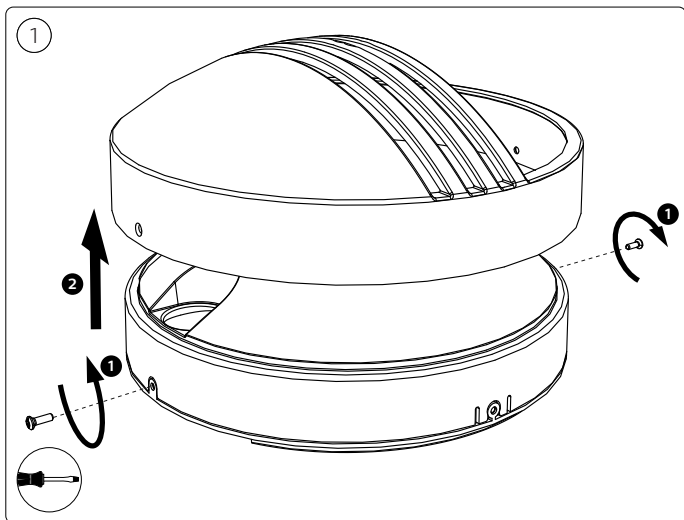
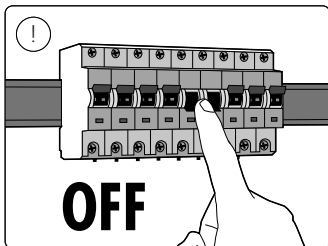
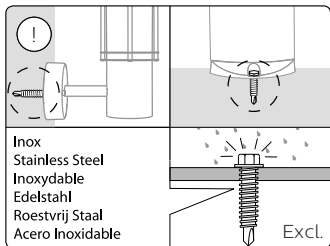

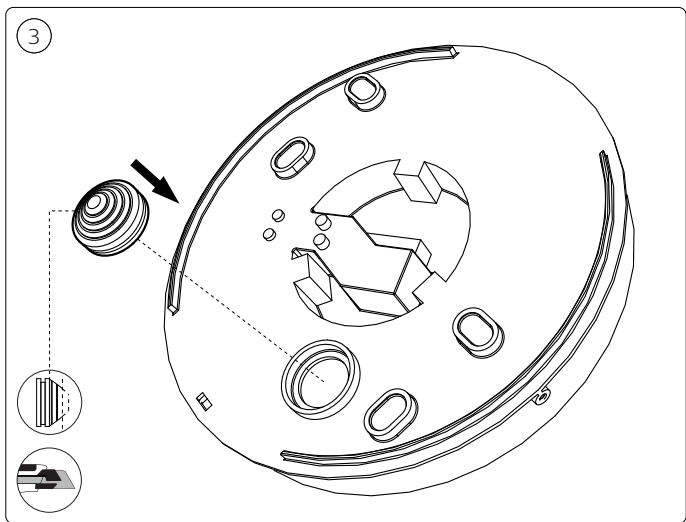
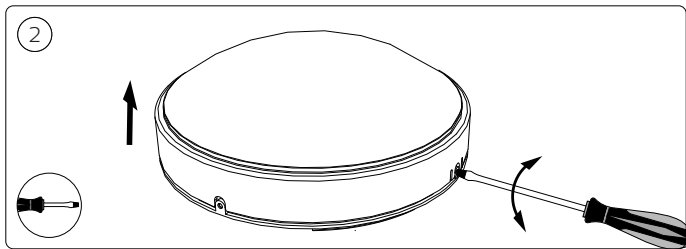



6

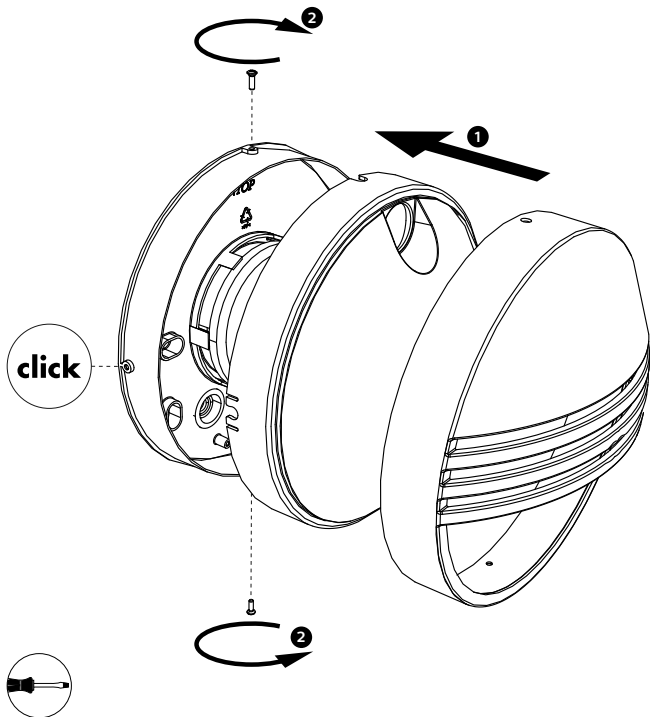

6

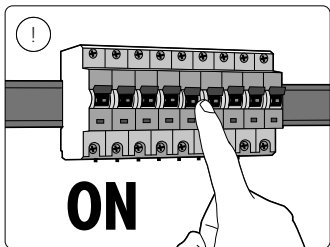
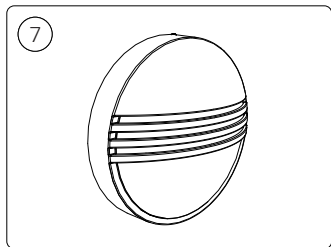



Signify  
I.B.R.S. / C.C.R.I. Numéro 10461  
5600 VB Eindhoven,  
the Netherlands  
☎00800-74454775

© 2021 Signify Holding  
All rights reserved

[www.philips.com/lighting](http://www.philips.com/lighting)

17296/\*\*/16  
4404 029 00733  
Last update: 06/2021